

DIM* ANALOG

*Digital Implant Model ANALOG | Available for 24 implant systems in the nt-IQ library

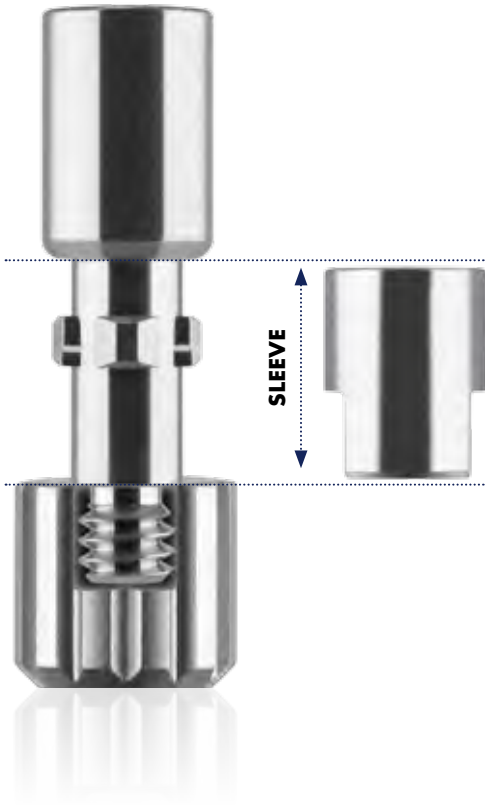

FEATURES:

- implant analog for digital model manufacturing in the model builder library
- two-piece repositionable implant analog
- precise positioning
- positional adjustment possible
- analog design supports precise repositioning of removable gingiva mask



APPLICATION:

- for model manufacturing in digital workflow



TECHNICAL DETAILS:

- Stainless Steel
- Titanium Grade 5 ELI



**INTERNATIONAL
PATENT PENDING**



**DIM PARALLEL DRILL
FOR PLASTER MODEL**



W 16.DIM.000

Notice: Products indicated with ® and ™ are registered brand names of the respective manufactures. Products indicated with * are available in the USA

TABLE OF CONTENTS

NT CATALOGUE 2017-1

1	TITANIUM BASE ABUTMENT	10 – 49
2	2-CONnect® ABUTMENT	50 – 117
3	NT-PREFORMS® ABUTMENT	118 – 147
4	DIM ANALOG	148 – 161
5	SURGICAL GUIDE SLEEVES	163 – 165
6	TOOLS & DISCS	167 – 181
7	NT-iDent	182 – 189
8	SPECIFICATION	190 – 191

BEG-SERIES – NEW

is compatible to: BEGO Implant Systems® / Semados®
S, RS-RX, RI-Line - - - - - 150

BIO-SERIES – NEW

is compatible to: BioHorizons® / internal- - - - - 150

BRE-SERIES – NEW

is compatible to: Bredent Medical® / Sky® - - - - - 151

CAM-SERIES

is compatible to: Altatec® / Camlog® - - - - - 151

COL-SERIES

is compatible to: Altatec® / Conelog® - - - - - 152

E-SERIES

is compatible to: Nobel Biocare™ / Replace Select®- - - - - 152

F-SERIES

is compatible to: Nobel Biocare™ / Nobel Active™ - - - - - 153

H-SERIES

is compatible to: Biomet 3i® / Certain® - - - - - 153

HIO-SERIES – NEW

is compatible to: HIOSSEN® / OSSTEM TS® - - - - - 154

I-SERIES

is compatible to: Biomet 3i® / Osseotite® External Hex® - - 154

K-SERIES

is compatible to: Nobel Biocare™ / Brånemark® - - - - - 155

L-SERIES

is compatible to: Straumann / Bone Level®- - - - - 155

MEX-SERIES – NEW

is compatible to: Medentis Medical® / ICX®- - - - - 156

MIC-SERIES – NEW

is compatible to: MIS® / C1® - - - - - 156

MIS-SERIES – NEW

is compatible to: MIS® / SEVEN®- - - - - 157

N-SERIES

is compatible to: Straumann / SynOcta® - - - - - 157

NEO-SERIES – NEW

is compatible to: NEOSS Implant System® / NEOSS™ - - - - - 158

R-SERIES

is compatible to: Zimmer Dental / Tapered Screw-Vent® - - 158

S-SERIES

is compatible to: DENTSPLY Implants® /
Astra Tech Implant System OsseoSpeed® TX - - - - - 159

SEV-SERIES – NEW

is compatible to: DENTSPLY Implants® /
Astra Tech Implant System™ EV - - - - - 159

T-SERIES

is compatible to: DENTSPLY Implants® / Xive®- - - - - 160

THO-SERIES – NEW

is compatible to: Thommen Medical® / SPI® - - - - - 160

UPR-SERIES – NEW

is compatible to: Sweden & Martina Implantology™ /
Premium Kohno®- - - - - 161

UTG-SERIES – NEW

is compatible to: Sweden & Martina Implantology™ /
Premium TG®- - - - - 161



NEW

BEG-SERIES DIM ANALOG









compatible to: BEGO Implant Systems® / Semados® S, RS-RX, RI-Line

					
PLATFORM	3,25 / 3,75 mm	4,1 mm	4,5 mm	5,5 mm	
					
DIM ANALOG	BEG 5.DIM.323	BEG 5.DIM.410	BEG 5.DIM.450	BEG 5.DIM.550	★
					
SLEEVE for plaster model Stainless Steel	DIM 5.XSL.A20	DIM 5.XSL.A20	DIM 5.XSL.A30	DIM 5.XSL.A30	★

BIO-SERIES DIM ANALOG

compatible to: BioHorizons® / internal

NEW

					
PLATFORM	3,0 mm	3,5 mm	4,5 mm	5,7 mm	
					
DIM ANALOG	BIO 5.DIM.300	BIO 5.DIM.350	BIO 5.DIM.450	BIO 5.DIM.570	★
					
SLEEVE for plaster model Stainless Steel	DIM 5.XSL.A10	DIM 5.XSL.A10	DIM 5.XSL.A30	DIM 5.XSL.A60	★

Notice: Products indicated with ® and ™ are registered brand names of the respective manufactures. Products indicated with ★ are available in the USA 

BRE-SERIES DIM ANALOG

compatible to: *Bredent Medical® / Sky®*



PLATFORM

3,5 mm

4,0 mm

DIM ANALOG



BRE 5.DIM.350

BRE 5.DIM.400



SLEEVE

for plaster model
Stainless Steel



DIM 5.XSL.A20

DIM 5.XSL.A20



CAM-SERIES DIM ANALOG

compatible to: *Altatec® / Camlog®*



PLATFORM

3,3 mm

3,8 mm

4,3 mm

5,0/6,0 mm

DIM ANALOG



CAM 5.DIM.330

CAM 5.DIM.380

CAM 5.DIM.430

CAM 5.DIM.506



SLEEVE

for plaster model
Stainless Steel



DIM 5.XSL.A10

DIM 5.XSL.A40

DIM 5.XSL.A40

DIM 5.XSL.A50



Notice: Products indicated with ® and ™ are registered brand names of the respective manufactures.
Products indicated with ★ are available in the USA

COL-SERIES DIM ANALOG

compatible to: Altatec® / Conelog®



PLATFORM

3,3 mm

3,8 / 4,3 mm

5,0 mm

DIM ANALOG



COL 5.DIM.330

COL 5.DIM.384

COL 5.DIM.500

★

SLEEVE

for plaster model
Stainless Steel



DIM 5.XSL.A10

DIM 5.XSL.A20

DIM 5.XSL.A30

★

E-SERIES DIM ANALOG

compatible to: Nobel Biocare™ / Replace Select®



PLATFORM

3,5 mm NP

4,3 mm RP

5,0 mm WP

6,0 mm

DIM ANALOG



E 5.DIM.350

E 5.DIM.430

E 5.DIM.500

E 5.DIM.600

★

SLEEVE

for plaster model
Stainless Steel



DIM 5.XSL.A10

DIM 5.XSL.A20

DIM 5.XSL.A30

DIM 5.XSL.A60

★

Notice: Products indicated with ® and ™ are registered brand names of the respective manufactures.
Products indicated with ★ are available in the USA 

F-SERIES DIM ANALOG

compatible to: Nobel Biocare™ / Nobel Active™



PLATFORM

3,5 mm NP

4,3 / 5,0 mm RP

DIM ANALOG



F 5.DIM.350

F 5.DIM.435

★

SLEEVE

for plaster model
Stainless Steel



DIM 5.XSL.A10

DIM 5.XSL.A20

★

H-SERIES DIM ANALOG

compatible to: Biomet 3i® / Certain®



PLATFORM

3,4 mm NP

4,1 mm RP

5,0 mm WP

DIM ANALOG



H 5.DIM.340

H 5.DIM.410

H 5.DIM.500

★

SLEEVE

for plaster model
Stainless Steel



DIM 5.XSL.A10

DIM 5.XSL.A20

DIM 5.XSL.A30

★

Notice: Products indicated with ® and ™ are registered brand names of the respective manufactures.
Products indicated with ★ are available in the USA 

NEW

HIO-SERIES DIM ANALOG

compatible to: HIOSSEN® / OSSTEM TS®



PLATFORM

3,5 mm

4,0 - 6,0 mm

DIM ANALOG



HIO 5.DIM.350

HIO 5.DIM.406

★

SLEEVE

for plaster model
Stainless Steel



DIM 5.XSL.A10

DIM 5.XSL.A20

★

I-SERIES DIM ANALOG

compatible to: Biomet 3i® / Osseotite® External Hex®



PLATFORM

3,4 mm

4,1 mm

5,0 mm

DIM ANALOG



I 5.DIM.340

I 5.DIM.410

I 5.DIM.500

★

SLEEVE

for plaster model
Stainless Steel



DIM 5.XSL.A10

DIM 5.XSL.A20

DIM 5.XSL.A30

★

Notice: Products indicated with ® and ™ are registered brand names of the respective manufactures.
Products indicated with ★ are available in the USA

K-SERIES DIM ANALOG

compatible to: Nobel Biocare™ / Brånemark®



PLATFORM

3,5 mm

4,1 mm

5,1 mm

DIM ANALOG



K 5.DIM.350

K 5.DIM.410

K 5.DIM.510

★

SLEEVE

for plaster model
Stainless Steel



DIM 5.XSL.A10

DIM 5.XSL.A20

DIM 5.XSL.A30

★

L-SERIES DIM ANALOG

compatible to: Straumann / Bone Level®



PLATFORM

3,3 mm NC

4,1 / 4,8 mm RC

DIM ANALOG



L 5.DIM.330

L 5.DIM.414

★

SLEEVE

for plaster model
Stainless Steel



DIM 5.XSL.A10

DIM 5.XSL.A20

★

Notice: Products indicated with ® and ™ are registered brand names of the respective manufactures.
Products indicated with ★ are available in the USA 

NEW

MEX-SERIES DIM ANALOG

compatible to: Medentis Medical® / ICX®



PLATFORM

3,45 - 4,8 mm

DIM ANALOG



MEX 5.DIM.414

★

SLEEVE

for plaster model
Stainless Steel



DIM 5.XSL.A20

★

MIC-SERIES DIM ANALOG

compatible to: MIS® / C1®

NEW



PLATFORM

3,3 mm NP

3,75 / 4,2 mm SP

5,0 mm WP

DIM ANALOG



MIC 5.DIM.330

MIC 5.DIM.374

MIC 5.DIM.500

★

SLEEVE

for plaster model
Stainless Steel



DIM 5.XSL.A10

DIM 5.XSL.A20

DIM 5.XSL.A30

★

Notice: Products indicated with ® and ™ are registered brand names of the respective manufactures.
Products indicated with ★ are available in the USA









MIS-SERIES DIM ANALOG

compatible to: MIS® / SEVEN®

				
PLATFORM	3,3 mm NP	3,75 / 4,2 mm SP	5,0 mm WP	
DIM ANALOG				
	MIS 5.DIM.330	MIS 5.DIM.374	MIS 5.DIM.500	★
SLEEVE for plaster model Stainless Steel				
	DIM 5.XSL.A10	DIM 5.XSL.A20	DIM 5.XSL.A30	★

N-SERIES DIM ANALOG

compatible to: Straumann / SynOcta®

				
PLATFORM	3,5 mm NN	4,8 mm RN	6,5 mm WN	
DIM ANALOG				
	N 5.DIM.350	N 5.DIM.480	N 5.DIM.650	★
SLEEVE for plaster model Stainless Steel				
	DIM 5.XSL.A10	DIM 5.XSL.A20	DIM 5.XSL.A30	★

Notice: Products indicated with ® and ™ are registered brand names of the respective manufactures. Products indicated with ★ are available in the USA 

NEW

NEO-SERIES DIM ANALOG

compatible to: *NEOSS Implant System® / NEOSS™*



PLATFORM

3,5 - 5,5 mm

DIM ANALOG



NEO 5.DIM.355 ★

SLEEVE

for plaster model
Stainless Steel



DIM 5.XSL.A20 ★

R-SERIES DIM ANALOG

compatible to: *Zimmer Dental / Tapered Screw-Vent®*



PLATFORM

3,5 mm

4,5 mm

5,7 mm

DIM ANALOG



R 5.DIM.350

R 5.DIM.450

R 5.DIM.570 ★

SLEEVE

for plaster model
Stainless Steel



DIM 5.XSL.A10

DIM 5.XSL.A20

DIM 5.XSL.A30 ★

Notice: Products indicated with ® and ™ are registered brand names of the respective manufactures.
Products indicated with ★ are available in the USA

S-SERIES DIM ANALOG

compatible to: DENTSPLY Implants® / Astra Tech Implant System OsseoSpeed® TX



PLATFORM

3,5 / 4,0 mm

4,5 / 5,0 mm

DIM ANALOG



S 5.DIM.354

S 5.DIM.455

★

SLEEVE

for plaster model
Stainless Steel



DIM 5.XSL.A10

DIM 5.XSL.A20

★

SEV-SERIE DIM ANALOG

compatible to: DENTSPLY Implants® / Astra Tech Implant System™ EV

NEW



PLATFORM

3,0 mm

3,6 mm

4,2 mm

4,8 mm

5,4 mm

DIM ANALOG



SEV 5.DIM.300

SEV 5.DIM.360

SEV 5.DIM.420

SEV 5.DIM.480

SEV 5.DIM.540

★

SLEEVE

for plaster model
Stainless Steel



DIM 5.XSL.A10

DIM 5.XSL.A10

DIM 5.XSL.A20

DIM 5.XSL.A30

DIM 5.XSL.A30

★

Notice: Products indicated with ® and ™ are registered brand names of the respective manufactures.
Products indicated with ★ are available in the USA

T-SERIES DIM ANALOG

compatible to: DENTSPLY Implants® / Xive®

				
PLATFORM	3,4 mm	3,8 mm	4,5 mm	5,5 mm
DIM ANALOG				
	T 5.DIM.340	T 5.DIM.380	T 5.DIM.450	T 5.DIM.550 ★
SLEEVE for plaster model Stainless Steel				
	DIM 5.XSL.A10	DIM 5.XSL.A20	DIM 5.XSL.A20	DIM 5.XSL.A30 ★

THO-SERIES DIM ANALOG

compatible to: Thommen Medical® / SPI®



					
PLATFORM	3,5 mm	4,0 mm	4,5 mm	5,0 mm	6,0 mm
DIM ANALOG					
	THO 5.DIM.350	THO 5.DIM.400	THO 5.DIM.450	THO 5.DIM.500	THO 5.DIM.600 ★
SLEEVE for plaster model Stainless Steel					
	DIM 5.XSL.A10	DIM 5.XSL.A20	DIM 5.XSL.A20	DIM 5.XSL.A30	DIM 5.XSL.A30 ★

Notice: Products indicated with ® and ™ are registered brand names of the respective manufactures. Products indicated with ★ are available in the USA 

NEW

UPR-SERIES DIM ANALOG

compatible to: Sweden & Martina Implantology™ / Premium Kohno®



PLATFORM

3,3 mm

3,8 mm

4,25 mm

5,0 mm

DIM ANALOG



UPR 5.DIM.330

UPR 5.DIM.380

UPR 5.DIM.420

UPR 5.DIM.500

★

SLEEVE

for plaster model
Stainless Steel



DIM 5.XSL.A10

DIM 5.XSL.A20

DIM 5.XSL.A20

DIM 5.XSL.A30

★

UTG-SERIES DIM ANALOG

compatible to: Sweden & Martina Implantology™ / Premium TG®



PLATFORM

3,3 - 4,25 mm

5,0 mm

DIM ANALOG



UTG 5.DIM.334

UTG 5.DIM.500

★

SLEEVE

for plaster model
Stainless Steel



DIM 5.XSL.A20

DIM 5.XSL.A30

★

NEW

Notice: Products indicated with ® and ™ are registered brand names of the respective manufactures.
Products indicated with ★ are available in the USA 🇺🇸